

Flow Control Valves

Series MTKA, MTQA

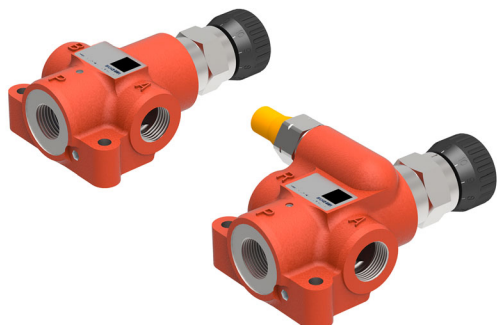

- robust, uncomplicated, reliable
- these valves do not require maintenance. This lowers costs and reduces the risk of a system failure.
- can be provided with mechanical actuation
- flow rates are unaffected by temperature change or when the higher load pressure alternates between the outlet ports
- line mounting design

1 Description

1.1 MTKA flow control valve

The MTKA priority flow control valve divides the inlet flow P into a priority flow A (fixed, or manually adjustable) and a surplus flow B. The surplus flow can be pressurised and can therefore be supplied to an additional actuator. The pressure in the inlet line corresponds to that of the actuator with the highest load.

For applications with high vibrations we recommend the version with detent (MTKAR).

When used as a 2-way flow control valve, the surplus flow outlet port (B) is plugged. For this application, please order the .../20 special feature.

1.2 MTQA flow control valve

The MTQA priority flow control valve divides the inlet flow P into a priority flow A (fixed, or manually adjustable) and a surplus flow R. The whole inlet flow is protected by an adjustable pressure relief valve. The surplus flow from port R should be returned directly to tank. The pressure in the inlet line corresponds to that of the actuator.

The pressure relief valve is set by the factory according to the customer's specifications and provided with a safety cap.

For applications with high vibrations we recommend the version with detent (MTQAR).

1.3 Application examples

The valves are used to regulate the speed of hydraulic actuators (cylinders, motors, etc.).

- Harvesters
- Municipal vehicles
- Forestry machines
- Construction equipment
- External propelled OFF-Highway machines

2 Symbols

2.1 MTKA...

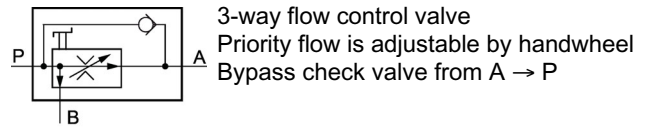
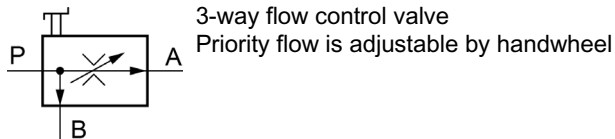
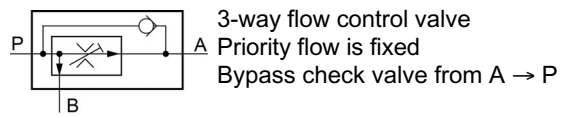
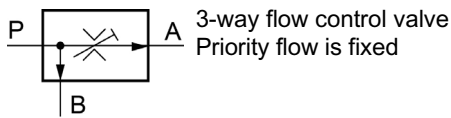

A	Priority flow	P	Pump
B	Surplus flow (can be pressurised)		

2.2 MTQA...

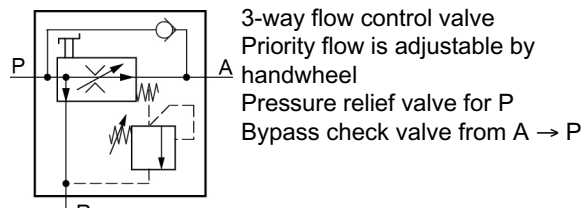
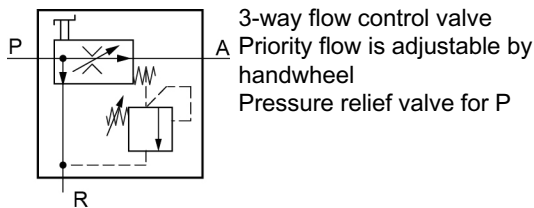
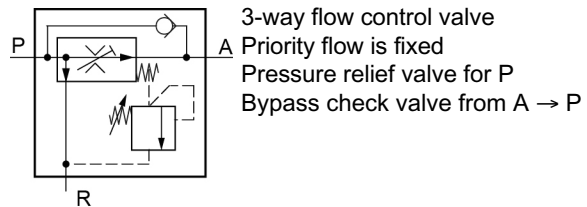
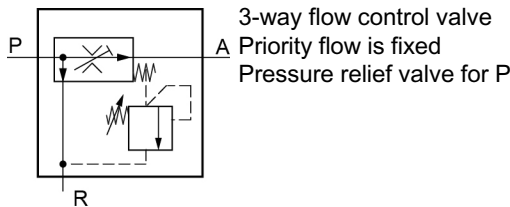

A	Priority flow	P	Pump
		R	Return line to tank

3 Technical data

Hydraulic characteristics	Unit	Description, value
Maximum operating pressure	bar	315
Nominal flow rate Q (inlet flow)	l/min	max. 70
Priority flow, fixed setting ¹⁾	l/min	min. 3; max. 65 (in steps of 1 l)
Priority flow, adjustable ¹⁾	l/min	0 ... 65
Control accuracy		± 5 %
Pressure differential Δp	bar	3,5 ... 5
Fluids		mineral oil to DIN 51524 (other fluids on request)
Fluid cleanliness		ISO 4406 class 20/18/15
Fluid temperature range	°C	-20 ... +80
Viscosity range	mm ² /s	10 ... 300
Leakage, priority flow, at min. control setting ²⁾	cm ³ /min	max. 50 (for MTKA.../20" max. 250)

1) For other priority flows/flow ranges, contact Bucher Hydraulics.

2) Measured with surplus flow not under pressure and 30mm³/s.

4 Performance graphs

The values refer to a viscosity of 33 mm²/s. Flow from P to A varies with the scale setting (adjustable models).

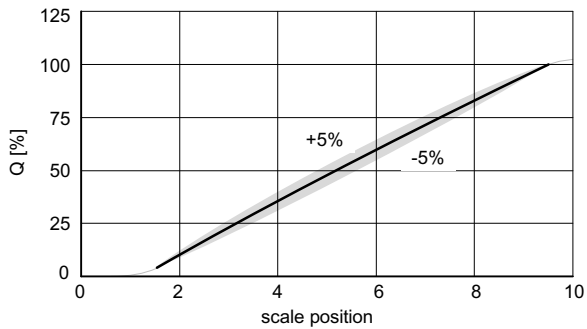

5 Dimensions (all dimensions in mm)

5.1 MTKA

fixed

adjustable

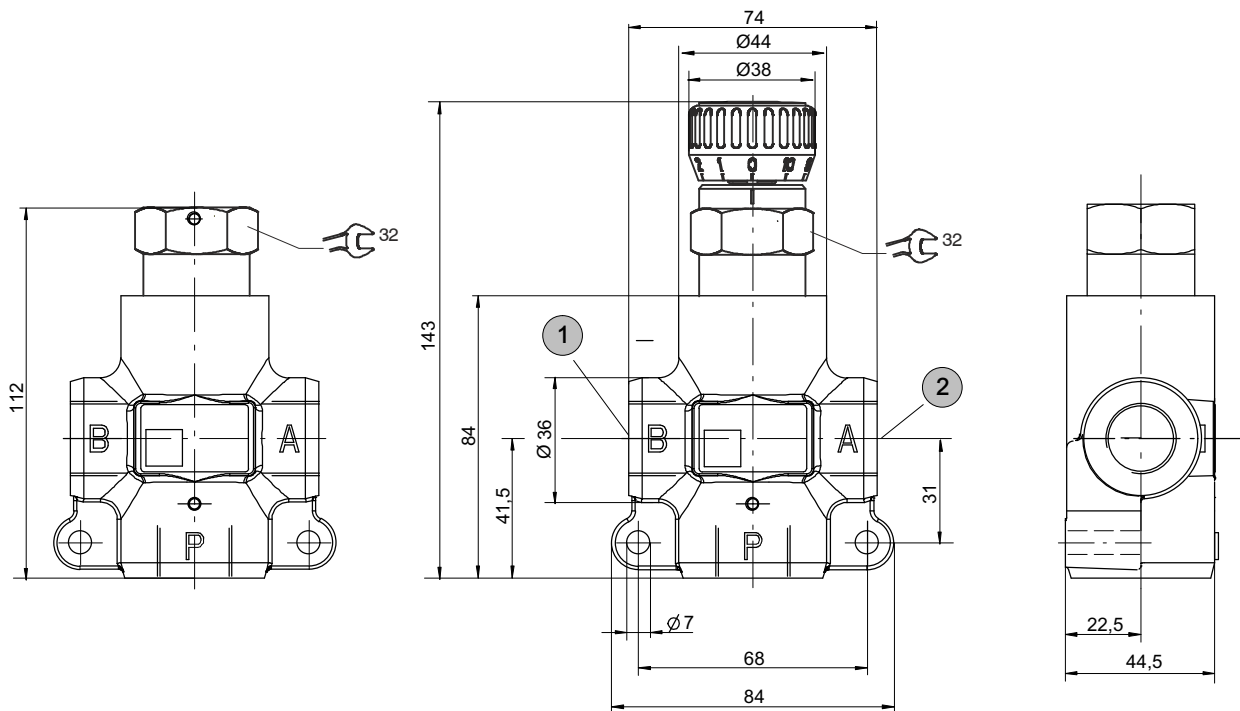

1 Surplus flow (option .../20 plugged)

2 Priority flow

5.1.1 Connection size

Port	MTKA...-M..	MTKA...-G..
P	M22 x 1,5	G1/2"
A		
B		

5.2 MTQA

fixed

adjustable

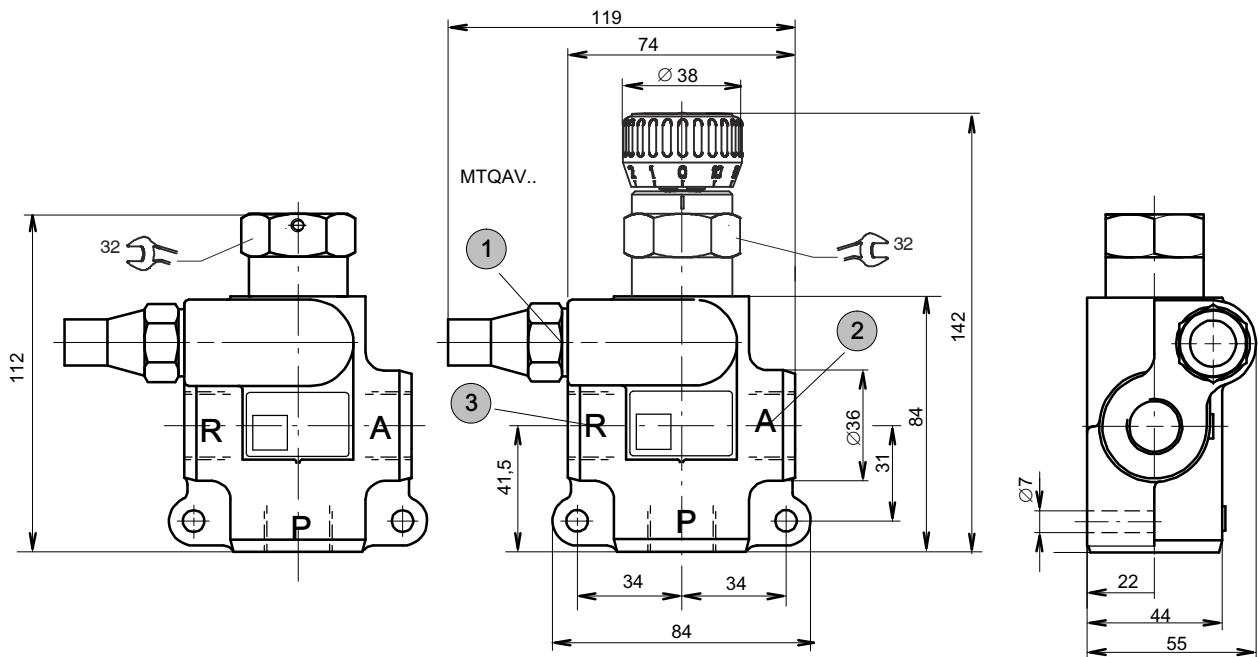

1	Pressure setting stamped here	2	Priority flow
3	Return line to tank		

5.2.1 Connection size

Port	MTQA...-M..	MTQA...-G..
P	M22 x 1,5	G½"
A		
B		

6 Ordering information

6.1 Model code and ID number for quick order MTKAV*

Model code	ID number
MTKAVE*-2G12	100028121
MTKAVG*-2G12	100034324
MTKAVA*-2G12	100020982
MTKAVK*-2G12	100027627
MTKAVB*-2G12	100021709
MTKAVH*-2G12	100030048
MTKAVC*-2G12	100021342
MTKA VD*-2G12	100021343

Model code	ID number
MTKAVE*-2M22	100029168
MTKAVG*-2M22	100032189
MTKAVA*-2M22	100020694
MTKAVK*-2M22	100031440
MTKAVB*-2M22	100020906
MTKAVH*-2M22	100026268
MTKAVC*-2M22	100020899
MTKA VD*-2M22	100021618

6.2 Model code key

6.2.1 MTKA

		M	T	K	A	V	A	R	-		M	2	2	/	
Flow control valve	MTKA,														
Priority flow range [l/min]															
Adjustable															
0 - 6 = VE	0 - 8 = VG	0 - 12 = VA	0 - 20 = VK												
0 - 25 = VB	0 - 35 = VH	0 - 50 = VC	0 - 65 = VD												
Adjustable with detent															
0 - 6 = RE	0 - 8 = RG	0 - 12 = RA	0 - 20 = RK												
0 - 25 = RB	0 - 35 = RH	0 - 50 = RC	0 - 65 = RD												
Fixed priority flow rate ¹⁾															
Min. 3 l; max. 65 l (in steps of 1 l)		= e.g. 09													
Bypass check valve from A to P		= R													
without		= *													
Design no.	(to be inserted by the factory)														
Ports A, B and P	M22x1,5 G 1/2"	= M22 = G12													
Option	.../20 = 2-way-flow control valve														

¹⁾ Setting with HLP46 and 50°C (30 mm²/s)

6.2.2 MTQA

		M	T	Q	A	V	A	R	-		M	2	2	P=250	
Stromregelventil	MTQA														
Priority flow range [l/min]															
Adjustable															
0 - 6 = VE	0 - 8 = VG	0 - 12 = VA	0 - 20 = VK												
0 - 25 = VB	0 - 35 = VH	0 - 50 = VC	0 - 65 = VD												
Adjustable with detent															
0 - 6 = RE	0 - 8 = RG	0 - 12 = RA	0 - 20 = RK												
0 - 25 = RB	0 - 35 = RH	0 - 50 = RC	0 - 65 = RD												
Fixed priority flow rate ¹⁾															
Min. 3 l; max. 65 l (in steps of 1 l)		= e.g. 09													
Bypass check valve from A to P		= R													
without		= *													
Design no.	(to be inserted by the factory)														
Ports A, R and P	M22x1,5 G 1/2"	= M22 = G12													
Setting for Pressure relief valve in P ¹⁾															
minimum 40 bar, maximum 315 bar (in steps of 5 bar)		= z.B. 250													

¹⁾ Setting with HLP46 and 50°C (30 mm²/s)

7 Mounting instructions

Expert and product knowledge is required for the layout of this valve type. Use exclusively for the intended purpose within the indicated values. The valve manufacturer must be consulted for use of the appliance outside the specifications. All applications must be verified by sufficient tests to ensure safety in the application. The ultimate responsibility for safety during installation and use resides with the end appliance manufacturer.

CAUTION:

Maintenance work may only be performed by expert personnel with mechanical knowledge. In principle, only the sealing parts may be replaced or checked. When replacing seals, ensure that they are well oiled or greased before mounting.